

## General Safety Information

### WARNING

- Use neutral detergent to clean the chain. Do not use alkali-based or acid based detergent such as rust cleaners as it may result in damage and/or failure of the chain.
- Be careful not to let the cuffs of your clothes get caught in the chain while riding, otherwise you may fall off the bicycle.
- Check that the tension of the chain is correct and that the chain is not damaged. If the tension is too weak or the chain is damaged, the chain should be replaced. If this is not done, the chain may break and cause serious injury.
- Check that there are no cracks in the crank arms before riding the bicycle. If there are any cracks, the crank arm may break and you may fall off the bicycle.
- The two left crank arm mounting bolts should be tightened alternately in stages rather than each bolt being fully tightened all at once. Use a torque wrench to check that the final tightening torques are within the range of 12 - 15 N·m.
- Furthermore, after riding approximately 100 km (60 miles), use a torque wrench to re-check the tightening torques.
- It is also important to periodically check the tightening torques.
- If the tightening torques are too weak or if the mounting bolts are not tightened alternately in stages, the left crank arm may come off and the bicycle may fall over.
- Obtain and read the service instructions carefully prior to installing the parts.** Loose, worn, or damaged parts may cause injury to the rider. We strongly recommend only using genuine Shimano replacement parts.
- Obtain and read the service instructions carefully prior to installing the parts.** If adjustments are not carried out correctly, the chain may come off and this may cause you to fall off the bicycle which could result in serious injury.
- Read these Technical Service Instructions carefully, and keep them in a safe place for later reference.

### Note

- In addition, if pedaling performance does not feel normal, check this once more.
- Before riding the bicycle, check that there is no play or looseness in the connection. Also, be sure to retighten the crank arm fixing bolt at periodic intervals. (BB-FC, FC-PD)
- Do not wash the bottom bracket with high-pressure jets of water.
- If you feel any looseness in the bottom bracket axle, the bottom bracket should be replaced.
- If gear shifting operations do not feel smooth, wash the derailleur and lubricate all moving parts.
- If the amount of looseness in the links is so great that adjustment is not possible, you should replace the derailleur.
- You should periodically wash the chainrings in a neutral detergent and then lubricate them again. In addition, cleaning the chain with neutral detergent and lubricating it can be an effective way of extending the useful life of the chainrings and the chain.
- If the chain keeps coming off the chainrings during use, replace the chainrings and the chain.
- Apply grease to the bottom bracket before installing it.
- For smooth operation, use the specified outer casing and the bottom bracket cable guide.
- When installing the top route type, choose a frame that has three outer casing holders as shown in the illustration at right.
- Use an outer casing which still has some length to spare even when the handlebars are turned all the way to both sides. Furthermore, check that the shifting lever does not touch the bicycle frame when the handlebars are turned all the way.
- A special grease is used for the gear shifting cable (SIS-SP41). Do not use DURA-ACE grease or other types of grease, otherwise they may cause deterioration in gear shifting performance.
- Grease the inner cable and the inside of the outer casing before use to ensure that they slide properly.
- Be sure to use only the applicable chain and bottom bracket.
- Make sure that the chainring combination matches the front chainwheel tooth configuration in the Product specifications table. If other combinations are used, the distance between the chainrings will be incorrect and the chain might slip off and get caught in between them.
- If the bottom bracket shell is not parallel, gear shifting performance will drop.
- To ensure the best performance, be sure to use only the specified type of chain. The wide type of chain cannot be used.
- Operation of the levers related to gear shifting should be made only when the front chainwheel is turning.
- Parts are not guaranteed against natural wear or deterioration resulting from normal use.
- For maximum performance we highly recommend Shimano lubricants and maintenance products
- For any questions regarding methods of installation, adjustment, maintenance or operation, please contact a professional bicycle dealer.

## Technical Service Instructions

SI-6MM0B-001

SL-S500 (-L)

Shifting lever

SHIMANO  
ALFINE

In order to realize the best performance, we recommend that the following combination be used.

|                            |                   |
|----------------------------|-------------------|
| Series                     | ALFINE            |
| Rapidfire (Shifting lever) | SL-S500 (-L)      |
| Outer casing               | SIS-SP41          |
| Front derailleur           | FD-R440           |
| Front chainwheel           | FC-4550-S         |
| Chain                      | CN-HG53 / CN-HG73 |
| Bottom bracket cable guide | SM-SP17 / SM-BT17 |

## Specifications

### Front Derailleur

|   |                            |
|---|----------------------------|
| Type  | Band type / Brazed on type |
| Front derailleur installation band diameter | S (28.6mm), M (31.8mm)     |
| Chainstay angle (α)                         | 61° - 66°                  |
| Chain line                                  | 43.5mm                     |

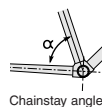

Chainstay angle

### Front chainwheel

|                                 |   |
|---------------------------------|---|
| Model number                    | FC-4550-S   |
| Chainwheel tooth combination    | 50 - 34T  |
| Bolt circle diameter            | 110 mm  |
| Crank arm length                | 165, 170, 175mm                                     |
| Pedal threads                   | B.C. 9/16" x 20T.P.I. (English thread)              |
| Applicable chain                | CN-HG53 / CN-HG73                                   |
| Chain line                      | 43.5 mm   |
| Shell width (Thread dimensions) | 68 mm (1.37 X 24 T.P.I.)<br>70 mm (M36 X 24 T.P.I.) |

## Installation of the chainrings

Smooth shifting will not be possible if the chainrings are incorrectly installed, so be sure to install the chainrings in the correct positions.

### Outer side

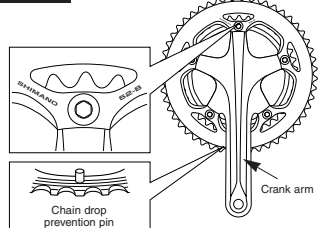

### Inner side

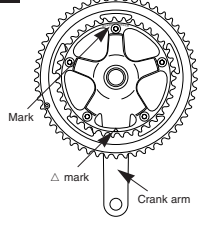

With the marked surface of the larger chainring facing out, set the larger chainring so that the chain drop prevention pin is lined up with the crank arm position.

With the marked surface of the smaller chainring facing away from the crank arm, set the chainring so that the Δ mark is lined up with the crank arm position. For chainrings without a marked surface, align using the projection on the inside of the chainring.

## Installation of the front chainwheel

Follow the procedure in the figure.

- Use the special tool TL-FC32 to install the right adapter (counterclockwise thread) and the left adapter (clockwise thread).  
Tightening torque: 35 - 50 N·m {305 - 435 in. lbs.}
- Insert the right crank unit.
- Set section A of the left crank into the axle of the right crank unit where the groove is wide.
- Use the TL-FC16 to tighten the cap.  
Tightening torque: 0.7 - 1.5 N·m {6 - 13 in. lbs.}
- Push in the stopper plate and check that the plate pin is securely in place, and then tighten the bolt of the left crank arm.  
**Note :** Each of the bolts should be evenly and equally tightened to 12 - 15 N·m {106 - 132 in. lbs.}.

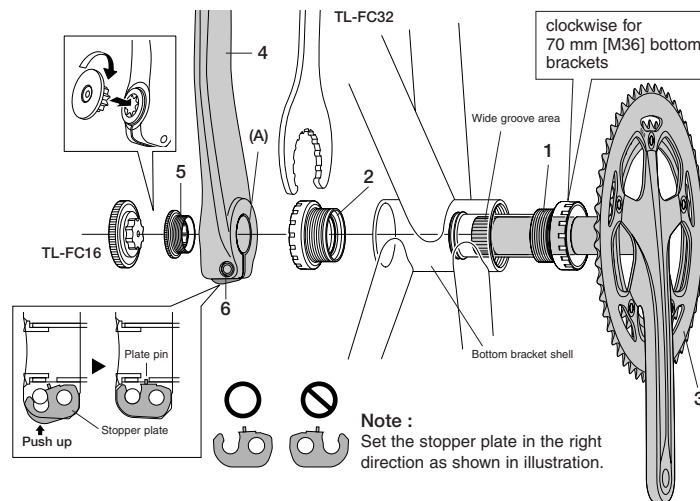

**Note :** Set the stopper plate in the right direction as shown in illustration.

## Installation of the front derailleur

- Adjust so that the clearance between the chain guide outer plate and the large gear is 1 - 3 mm before installing.

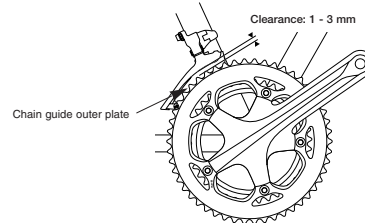

- The level section of the chain guide outer plate should be directly above and parallel to the largest chainring.

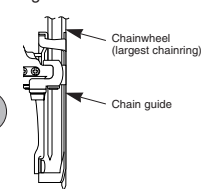

- Secure using a 5mm Allen key.

Tightening torque:  
5 - 7 N·m {44 - 60 in. lbs.}

## Chain length

With the chain on the large chainring, add two links to the chain.

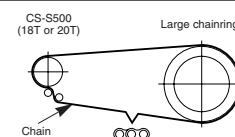

## Mounting the shifting lever

Use a handlebar grip with a maximum outer diameter of 32 mm.

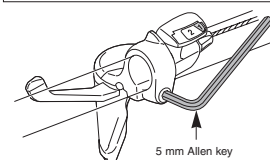

Tightening torque :  
5 N·m {44 in. lbs.}

- Install the shifting lever in a position where it will not obstruct brake operation and gear shifting operation.
- Do not use in a combination which causes brake operation to be obstructed.

## SIS adjustment

### 1. Low adjustment

Set so that the clearance between the chain guide inner plate and the chain is 0 - 0.5 mm.

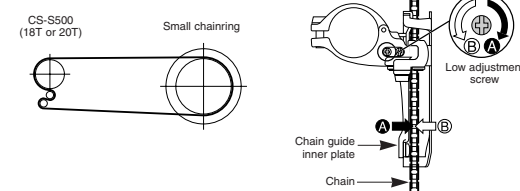

### 2. Connecting and securing the inner cable

Operate lever (B) 2 or more times, check on the indicator that the low position is correct, and then secure the inner cable.

While firmly pulling the inner cable, secure by tightening the fixing bolt with a 5 mm Allen key.

Tightening torque :  
5 - 7 N·m {44 - 60 in. lbs.}

Install the inner hole cover by turning it as shown in the illustration until it stops. Do not turn it any further than this, otherwise it may damage the screw thread.

In addition, if the unit cover becomes bent, it may cause the unit cover to get in the way of the feed lever and prevent the feed lever from operating correctly. If the feed lever does not return correctly, loosen the inner hole cover slightly, and then move the feed lever and the unit cover apart and check if this improves the returning of the feed lever.

Tightening torque :  
0.3 - 0.5 N·m {3 - 4 in. lbs.}

While pulling the inner cable, tighten the wire fixing bolt with a 5 mm allen key to secure the cable.

Tightening torque:  
5 - 7 N·m {44 - 60 in. lbs.}

After taking up the initial slack in the cable, re-secure to the front derailleur as shown in the illustration.

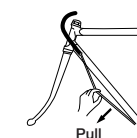

### Cutting the outer casing

When cutting the outer casing, cut the opposite end to the end with the marking. After cutting the outer casing, make the end round so that the inside of the hole has a uniform diameter.

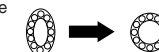

Attach the same outer end cap to the cut end of the outer casing.

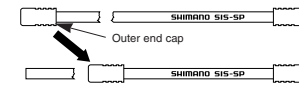

### 3. Top stroke adjustment

Set the chain onto the CS-S500 sprocket (sprocket with chainguard), and then shift to the large chainring.

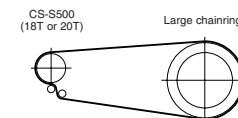

### (1) Stroke adjustment screw adjustment

Use the top adjustment screw to adjust the position of the chain guide plate (so that the gaps on the left and right sides of the chain are even).

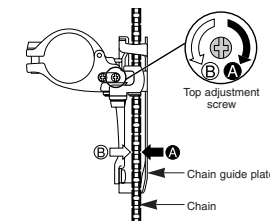

### (2) Adjustment of the inner cable tension

Turn the adjustment barrel of the shifting lever to adjust the inner cable tension to the correct tension.  
\* If too much tension is applied to the cable, lever operation may become stiff.

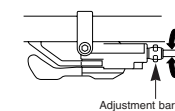

## Front shifting

Both lever (A) and lever (B) always return to the initial position when they are released after shifting. When operating one of the levers, always be sure to turn the crank arm at the same time.

### To shift from the small chainring to the large chainring (Lever A)

When lever (A) is pressed once, there is a shift of one step from the small chainring to the large chainring.

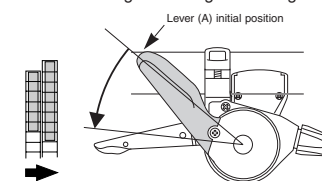

### To shift from the large chainring to the small chainring (Lever B)

When lever (B) is pressed once, there is a shift of one step from the large chainring to the small chainring.

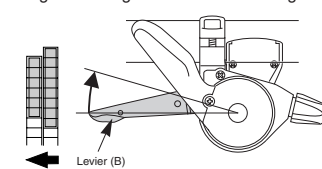

## Replacement of the indicator

Disassembly and reassembly should only be carried out when replacing the indicator.

- Remove the two cover fixing screws that are securing the indicator.

Tightening torque :  
0.3 - 0.5 N·m {3 - 4 in. lbs.}

- Remove the indicator unit as shown in the illustration.

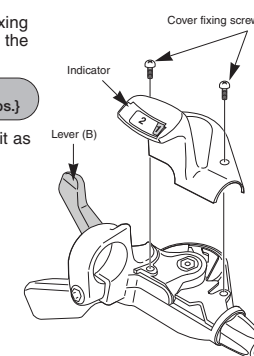

- Operate lever (B) two times or more to set the lever to the lowest position.

- After checking that the indicator needle is at the right edge, install the indicator from directly above.

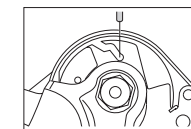

- Check the operation of the indicator. If it does not operate correctly, re-install the indicator by while taking particular note of steps 3. and 4.

Do not disassemble the indicator and shifting lever unit, as this may damage them or cause mis-operation.

This service instruction explains how to use and maintain the Shimano bicycle parts which have been used on your new bicycle. For any questions regarding your bicycle or other matters which are not related to Shimano parts, please contact the place of purchase or the bicycle manufacturer.

## SHIMANO

SHIMANO AMERICAN CORPORATION  
One Holland, Irvine, California 92618, U.S.A. Phone: +1-949-951-5003

SHIMANO EUROPE B.V.  
Industrieweg 24, 8071 CT Nunspeet, The Netherlands Phone: +31-341-272222

SHIMANO INC.  
3-77 Oimatsu-cho, Sakai-ku, Sakai-shi, Osaka 590-8577, Japan  
These service instructions are printed on recycled paper.  
Please note: specifications are subject to change for improvement without notice. (English)  
© Oct. 2006 by Shimano Inc. XBC SZK Printed in Japan.