

General Safety Information

WARNING

- Obtain and read the service instructions carefully prior to installing the parts. Loose, worn, or damaged parts may cause injury to the rider. We strongly recommend only using genuine Shimano replacement parts.
- Obtain and read the service instructions carefully prior to installing the parts. If adjustments are not carried out correctly, the chain may come off and this may cause you to fall off the bicycle which could result in serious injury.
- Be careful not to let the cuffs of your clothes get caught in the chain while riding, otherwise you may fall off the bicycle.
- Read these Technical Service Instructions carefully, and keep them in a safe place for later reference.

Note

- If gear shifting operations cannot be carried out smoothly, clean the derailleur and lubricate all moving parts.
- If the amount of looseness in the links is so great that adjustment is not possible, you should replace the derailleur.
- When the chain is in the position shown in the illustration, the chain may contact the front chainrings or front derailleur and generate noise. If the noise is a problem, shift the chain onto the next-larger rear sprocket or the one after.
- For smooth operation, use the specified outer casing and the bottom bracket cable guide.
- Grease the inner cable and the inside of the outer casing before use to ensure that they slide properly.
- Parts are not guaranteed against natural wear or deterioration resulting from normal use.
- For maximum performance we highly recommend Shimano lubricants and maintenance products.
- For any questions regarding methods of installation, adjustment, maintenance or operation, please contact a professional bicycle dealer.

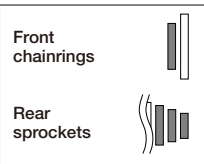

Technical Service Instructions

SI-5JT0A-001

FD-R770

Front derailleur

In order to realize the best performance, we recommend that the following combination be used.

Shifting lever	SL-R770
Outer casing	SP41
Gears	20
Front derailleur	FD-R770
Front chainwheel	FC-7800 / FC-6600 / FC-5600 / FC-R700
Rear derailleur	RD-7800 / RD-6600 / RD-5600
Freehub	FH-7800 / FH-6600 / FH-5600
Cassette sprocket	CS-7800 / CS-6600 / CS-5600
Chain	CN-7801 / CN-6600 / CN-5600
Bottom bracket cable guide	SM-SP17

Specifications

Type	Band type / Brazed on type
Front derailleur installation band diameter	S (28.6mm), M (31.8mm), L (34.9mm)
Front chainwheel tooth difference	16 teeth or less
Chainstay angle (α)	61° - 66°
Chain line	43.5mm

SHIMANO

SHIMANO AMERICAN CORPORATION
One Holland, Irvine, California 92618, U.S.A. Phone: +1-949-951-5003

SHIMANO EUROPE B.V.
Industrieweg 24, 8071 CT Nunspeet, The Netherlands Phone: +31-341-272222

SHIMANO INC.
3-77 Oimatsu-cho, Sakai-ku, Sakai-shi, Osaka 590-8577, Japan

Please note: specifications are subject to change for improvement without notice. (English)
© Marl. 2007 by Shimano Inc. XBC SZK Printed in Japan.

These service instructions are printed on recycled paper.

Front shifting (SL-R770)

Both lever (A) and lever (B) always return to the initial position when they are released after shifting. When operating one of the levers, always be sure to turn the crank arm at the same time.

To shift from a small chainring to a larger chainring

When lever (A) is pressed once, there is a shift of one step from a small chainring to a larger chainring.

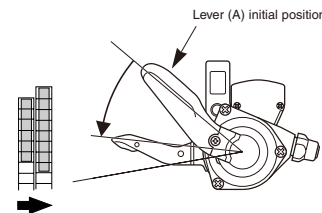

To shift from a large chainring to a smaller chainring

When lever (B) is pressed once, there is a shift of one step from a large chainring to a smaller chainring.

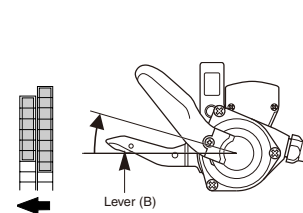

When lever (B) is operated, there is one click where trimming (the noise prevention mechanism) engages, and a second stronger click when the gear shift stroke is completed. After trimming, the next push will complete the gear shift stroke.

Trimming (noise prevention operation)

If the chain is on the large front chainwheel and the larger rear sprocket, the chain will rub in the front derailleur plate, producing a characteristic noise. When this happens, press lever (B) lightly (to the point where it clicks); this causes the front derailleur to move slightly towards the smaller chainwheel, thereby eliminating the noise.

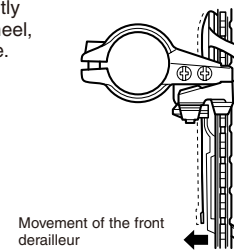
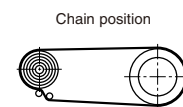
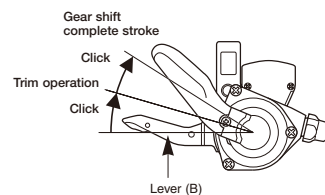

Installation of the front derailleur

1. Adjust so that the clearance between the chain guide outer plate and the large gear is 1 - 3 mm before installing.

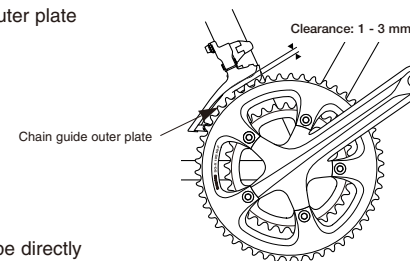

2. The level section of the chain guide outer plate should be directly above and parallel to the largest chainring.

3. Secure using a 5mm Allen key.

Tightening torque:
5 - 7 N·m
{44 - 60 in. lbs.}

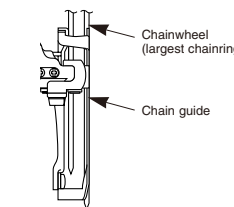

In the case of carbon frames, it may be necessary to lower the tightening torque in order to prevent damage to the frame. Please consult the bicycle or frame manufacturer regarding the appropriate level of tightening torque for carbon frames.

SIS adjustment

1. Low adjustment

Set so that the clearance between the chain guide inner plate and the chain is 0 - 0.5 mm.

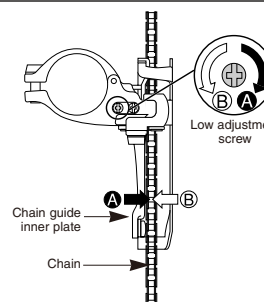
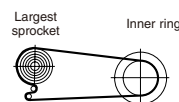

2. Connection and securing of cable

While pulling the inner cable, tighten the wire fixing bolt with a 5 mm allen key to secure the cable.

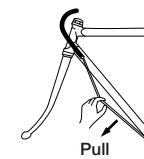

Tightening torque:
5 - 7 N·m {44 - 60 in. lbs.}

After taking up the initial slack in the cable, re-secure to the front derailleur as shown in the illustration.

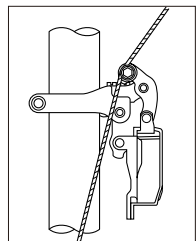

3. Top adjustment

Set so that the clearance between the chain guide outer plate and the chain is 0 - 0.5 mm.

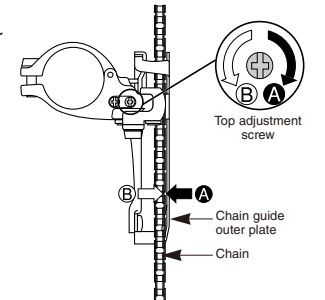
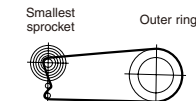

4. Adjustment of the cable tension

- (1) Set the chain to the largest rear sprocket, and shift the front to top gear.

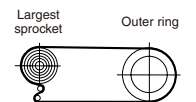

- (2) Perform the trimming.

While turning the crank arm, gently operate lever (B) and check that the front derailleur moves slightly toward the small chainring. If the front derailleur moves by a large amount and the chain is set onto the small chainring at this time, loosen the top adjustment bolt by 1/8th of a turn. Then, after returning the chain to its original position, adjust and check the trimming mechanism.

- (3) After trimming, adjust the clearance (by using the cable-adjustment bolt) of the chain and chain guide to the minimum (0 - 0.5 mm).

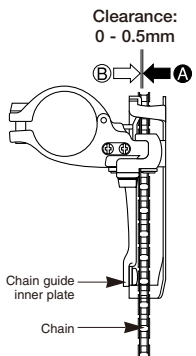
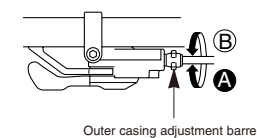
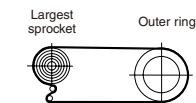

5. Troubleshooting chart

After completion of steps 1 - 4, move the shifting lever to check the shifting. (This also applies if shifting becomes difficult during use.)

If the chain falls to the crank side	Tighten the top adjustment screw clockwise (about 1/4 turn).
If shifting is difficult from the small chainring to the large chainring	Loosen the top adjustment screw counterclockwise (about 1/8 turn).
If shifting is difficult from the large chainring to the small chainring	Loosen the low adjustment screw counterclockwise (about 1/8 turn).
If the chain falls to the bottom bracket side.	Tighten the low adjustment screw clockwise (about 1/8 turn).
If the gear shifting to the small chainring is stiff and difficult to carry out after trimming.	Turn the outer casing adjustment bolt clockwise (1/8 of a turn at a time) until shifting to the small chainring becomes smooth. Be careful not to turn the outer casing adjustment bolt too far at this time, otherwise shifting to the large chainring will become more difficult.

Be sure to read these service instructions in conjunction with the service instructions for the SL-R770 before use.